

BOXER™

instruction manual



 **WARNING:**
CHOKING HAZARD – Small parts and small ball. Not for children under 3 years.



CAUTION: HAIR ENTANGLEMENT -

Tie back and cover hair and secure loose clothing prior to play.

For instructional video, visit www.boxerthebot.com or the Boxer Bot app.

6+



table of contents

CONTENTS	3
INTRODUCTION	4
HOW TO INSTALL BATTERIES	5
BATTERY SAFETY INFORMATION	6
BOXER FEATURES	7
REMOTE CONTROL FEATURES	8
CHARGING BOXER	9
GETTING STARTED	10
BOXER MODES	11
REMOTE CONTROL MODE	12
REMOTE CONTROL CHANNEL SELECT	13
PLAY MODE	14
APP MODE	16
GAME ACTIVITY MODE	17
GAME MODE: BOT BOWLING	18
GAME MODE: DJ BOT	19
GAME MODE: SOCCER	20
GAME MODE: PADDLE BOT	21
GAME MODE: GO KART	22
GAME MODE: DANCE PARTY	23
GAME MODE: FORTUNE TELLER	24
GAME MODE: STUNT SHOW	25
GAME MODE: LASER TANK	26
GAME MODE: SLING SHOT	27
SLEEP MODE	28
POWER OFF	28
TROUBLESHOOTING	29
WARNINGS	30-31

IMPORTANT INFORMATION: Remove all packaging before use. Retain this information and address for future reference. Content may vary from pictures.

BOXER INSTRUCTION MANUAL – Due to all the awesome features in Boxer, this guide should be used for reference only and may be modified. The most updated version is located at www.boxerthebot.com/help.

contents

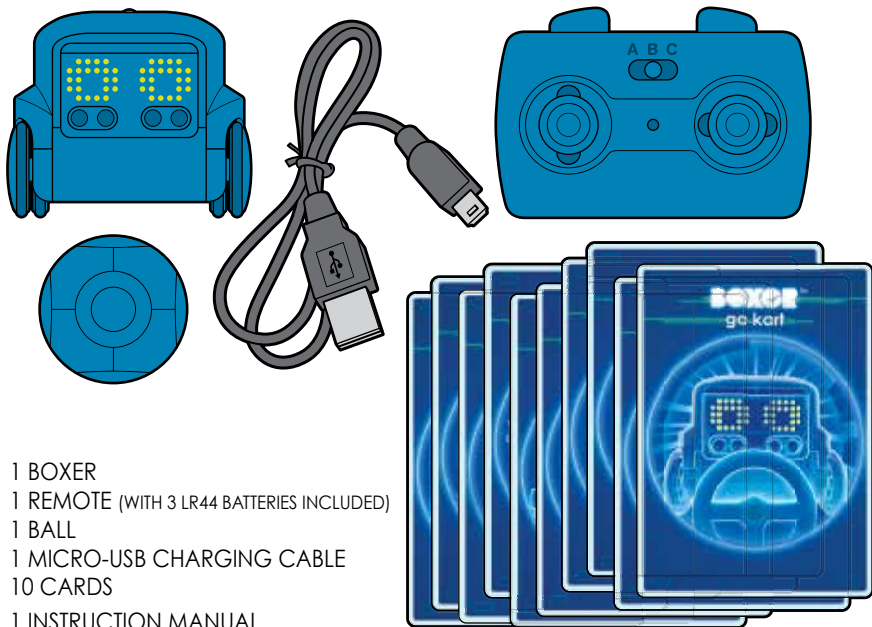

- 1 BOXER
- 1 REMOTE (WITH 3 LR44 BATTERIES INCLUDED)
- 1 BALL
- 1 MICRO-USB CHARGING CABLE
- 10 CARDS
- 1 INSTRUCTION MANUAL

introduction

hey there, i'm boxer!

your pint-sized freewheelin' robot who is always on the move.

i might be small, but my features are mighty cool. traveling with me is a collection of activity cards, a ball and a remote controller. i roll over and scan the cards with my sensors to unlock an assortment of super cool games we can play together. one second i'm taking fast turns like a go kart and the next i'm dropping beats as your personal dj. whatever it is, i will be your bud forever...

learn more about what gets my wheels spinning by reading these instructions.



how to replace batteries

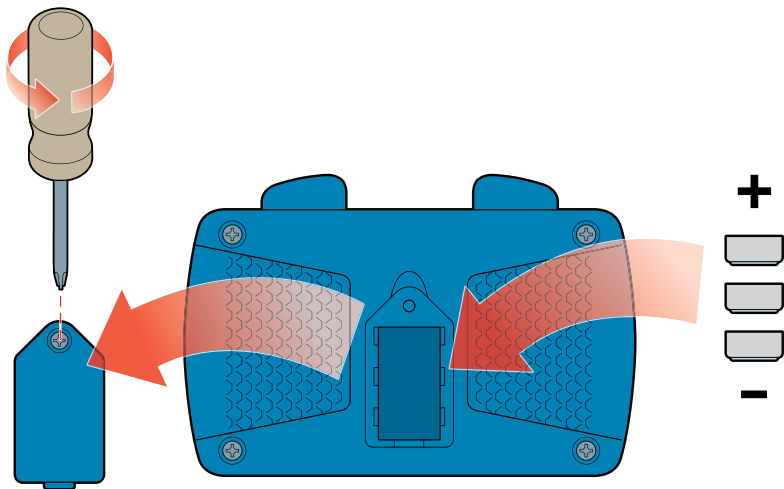

⚠ WARNING: KEEP BATTERIES OUT OF REACH OF CHILDREN

1. Open the battery door with a screwdriver (not included).
2. If used batteries are present, remove these batteries from the unit by pulling up on one end of each battery. DO NOT remove or install batteries using sharp or metal tools.
3. Install 3 new LR44 button cell batteries as shown in the polarity diagram (+/-) inside the battery compartment.
4. Replace battery door securely.
5. Check your local laws and regulations for correct recycling and/or battery disposal.

battery safety information

BATTERY SAFETY INFORMATION:

Batteries are small objects.

Replacement of batteries must be done by adults.

Follow the polarity (+/-) diagram in the battery compartment.

Promptly remove dead batteries from the toy.

Dispose of used batteries properly.

Remove batteries for prolonged storage.

Only batteries of the same or equivalent type as recommended are to be used.

DO NOT incinerate used batteries.

DO NOT dispose of batteries in fire, as batteries may explode or leak.

DO NOT mix old and new batteries or types of batteries (i.e. alkaline/standard/rechargeable).

Using rechargeable batteries is not recommended due to possible reduced performance.

Rechargeable batteries are only to be charged under adult supervision.

Replaceable-rechargeable batteries are to be removed from the toy before being charged.

DO NOT recharge non-rechargeable batteries.

DO NOT short-circuit the supply terminals.

 THIS PRODUCT CONTAINS A BUTTON OR COIN CELL BATTERY. A SWALLOWED BUTTON OR COIN CELL BATTERY CAN CAUSE INTERNAL CHEMICAL BURNS IN AS LITTLE AS TWO HOURS AND LEAD TO DEATH DUE TO CHEMICAL BURNS AND POTENTIAL PERFORATION OF THE ESOPHAGUS. DISPOSE OF USED BATTERIES IMMEDIATELY AND SAFELY. USED BATTERIES CAN STILL BE DANGEROUS. KEEP NEW AND USED BATTERIES AWAY FROM CHILDREN. IF YOU THINK BATTERIES MIGHT HAVE BEEN SWALLOWED OR PLACED INSIDE ANY PART OF THE BODY, SEEK IMMEDIATE MEDICAL ATTENTION.

FOR AUSTRALIA: IF YOU SUSPECT YOUR CHILD HAS SWALLOWED OR INSERTED A BUTTON BATTERY IMMEDIATELY CALL THE 24-HOUR POISONS INFORMATION CENTRE ON 13 11 26 FOR FAST, EXPERT ADVICE. EXAMINE DEVICES TO MAKE SURE THE BATTERY COMPARTMENT IS CORRECTLY SECURED, E.G., THAT THE SCREW OR OTHER MECHANICAL FASTENER IS TIGHTENED. DO NOT USE IF COMPARTMENT IS NOT SECURE. TELL OTHERS ABOUT THE RISK ASSOCIATED WITH BUTTON BATTERIES AND HOW TO KEEP THEIR CHILDREN SAFE.

anatomy of a boxer

FRONT

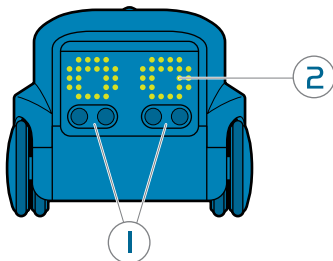

BACK

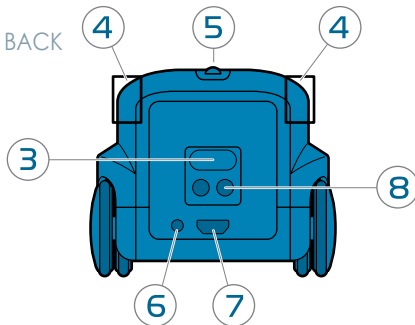

TOP

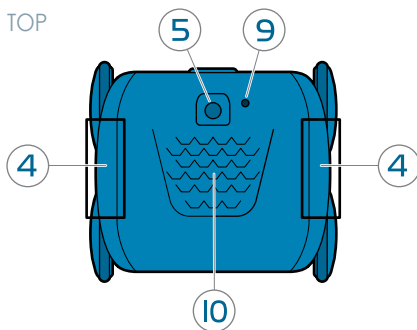

BOTTOM

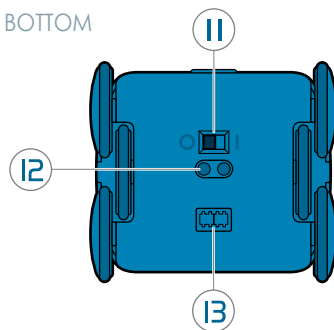

- 1. IR Sensors
- 2. LED Matrix
- 3. Button
- 4. Touch Sensors
- 5. RC Receiver

- 6. Battery Indicator
- 7. Micro USB Port
- 8. IR Sensors
- 9. Microphone
- 10. Speaker

- 11. On/Off Switch
- 12. Card Scanner
- 13. Line Follow Sensor

remote control features

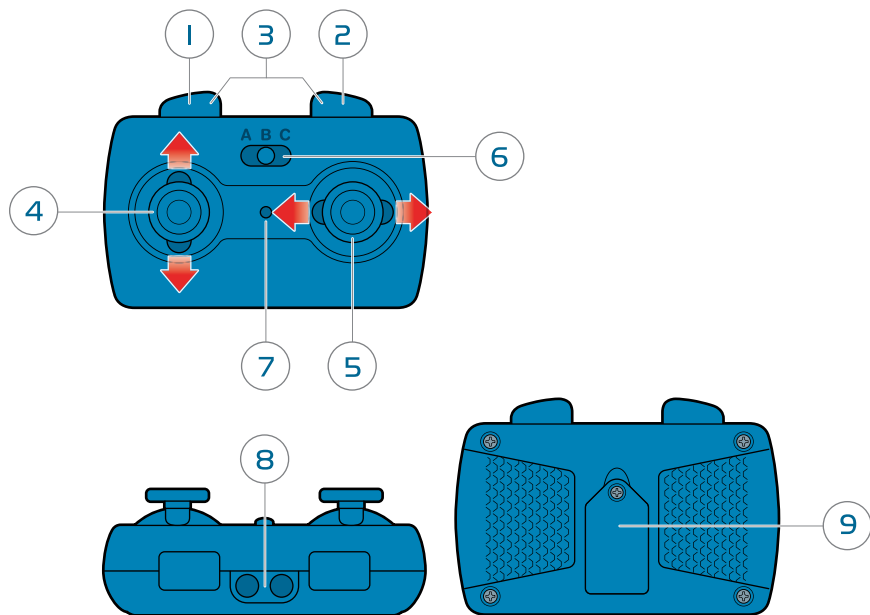

1. Left Stunt Button (Front Wheelie)
2. Right Stunt Button (Back Wheelie)
3. Stunt Buttons Together (Somersault)
4. Forward/Reverse Control
5. Left/Right & Spin Control

6. Channel Selector
7. Power Indicator
8. IR Sensors
9. Battery Compartment

charging boxer

Cable is for charging only. Boxer will only charge when turned off. Plug into appropriate power source. Rear LED will blink while charging. Charge for 1 hour. Red LED will glow solid when charged. Play time is approximately one hour per full charge.

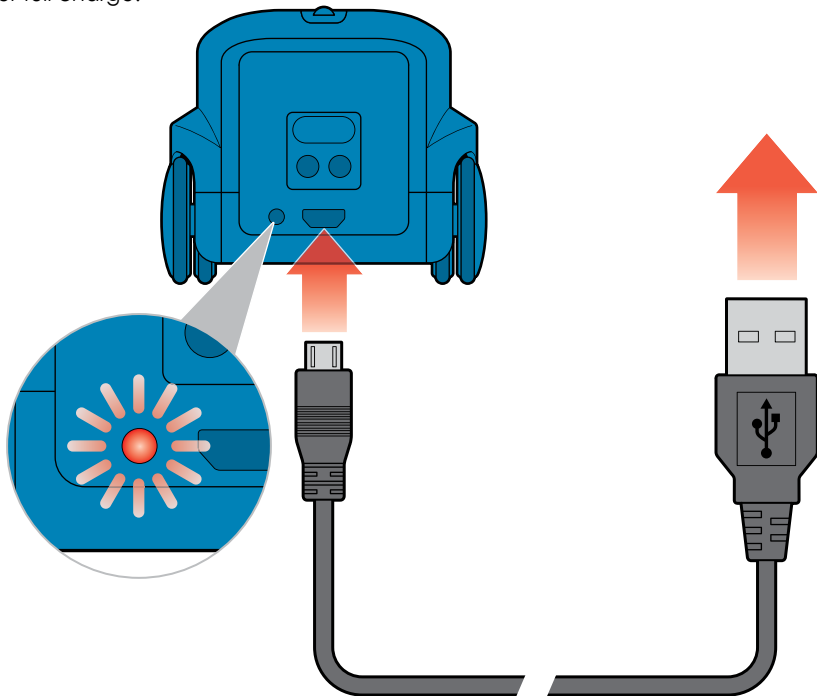

getting started

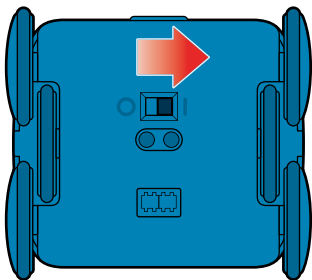

1. Move POWER SWITCH to ON (I) Position.

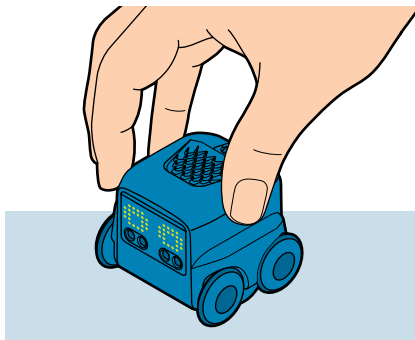

2. Put Boxer on flat surface.

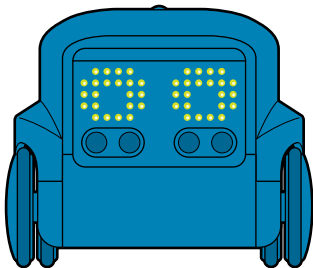

3. BOXER's eyes light up.

For best performance,
use on a smooth, light,
solid colored surface.

boxer modes

BOXER HAS 4 PLAY MODES:

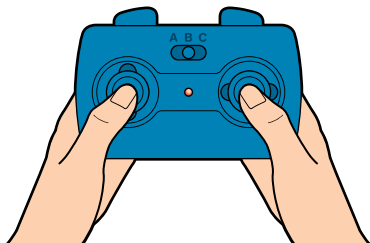

1. REMOTE CONTROL MODE

Control BOXER'S movements.

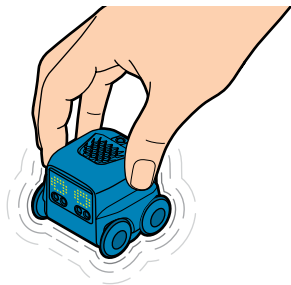

2. PLAY MODE

Interact with BOXER.



3. APP MODE

Connect BOXER to the APP.

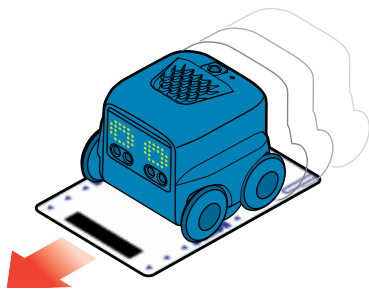

4. GAME ACTIVITY MODE

Scan an ACTIVITY CARD.

For instructional video, visit www.boxerthebot.com or the Boxer Bot app.

remote control mode

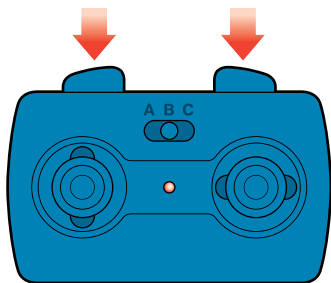

1. Activate REMOTE CONTROL by pressing one of the STUNT BUTTONS. Get within 4' distance. Red LED Lights up.

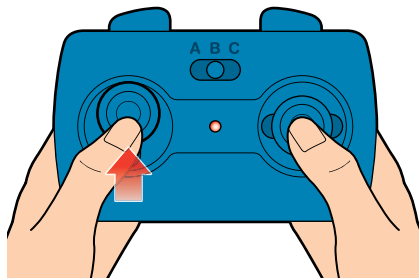

3. Press DIRECTION KNOB.

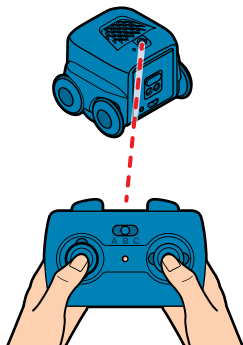

2. Point RC at BOXER.

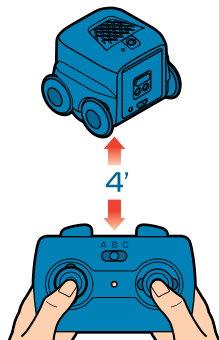

4. IDEAL RANGE: 4' Distance.

remote control channel select

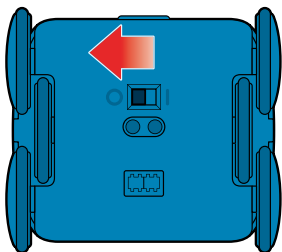

1. Make sure BOXER is OFF.

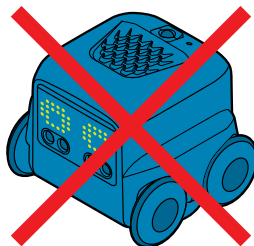

2. Make sure there are no other robots nearby.

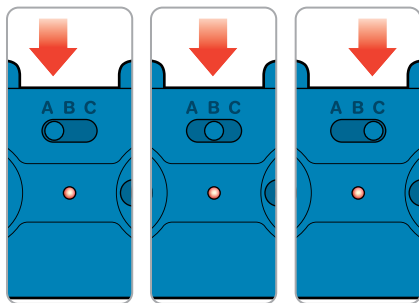

3. Select a UNIQUE CHANNEL (A-B-C) on the REMOTE CONTROL.

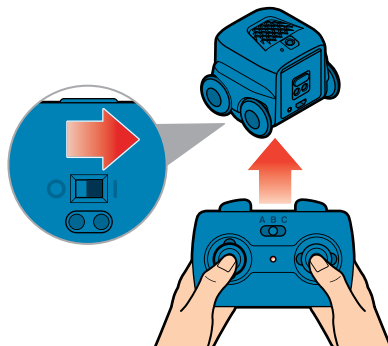

4. Turn BOXER ON, with the REMOTE CONTROL pointed at it.

play mode

Some of the many ways
to interact with BOXER.

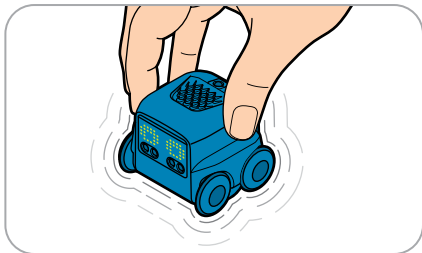
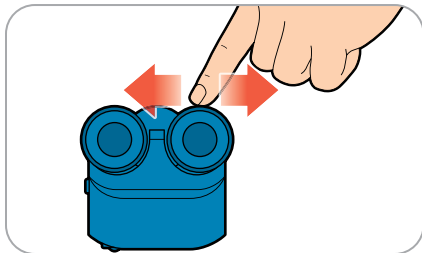
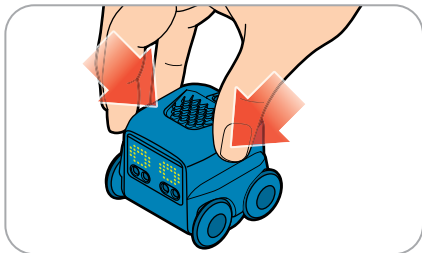
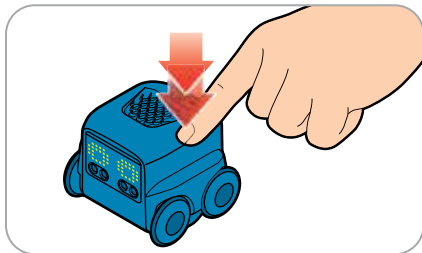
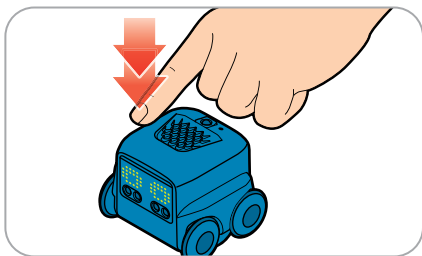

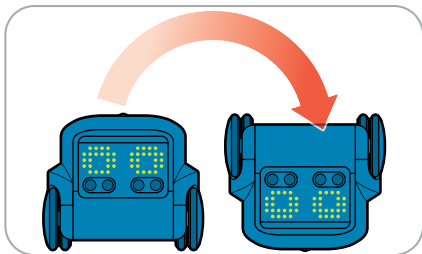
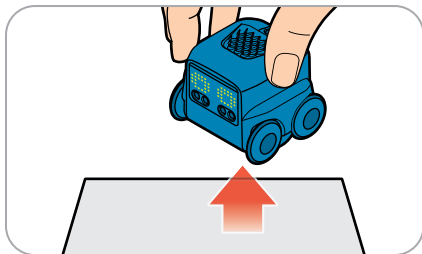
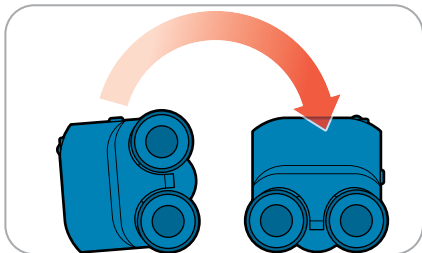
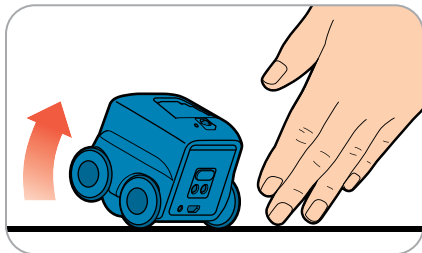
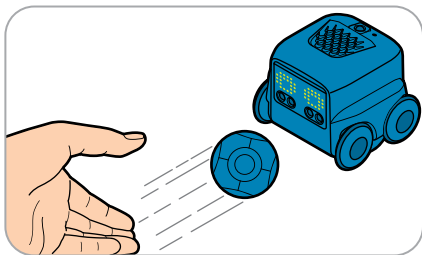
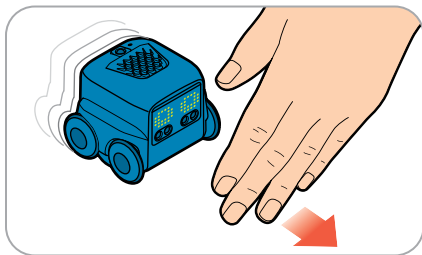

app mode

CONNECT TO APP:



1. Download the BOXER APP to a compatible mobile device.

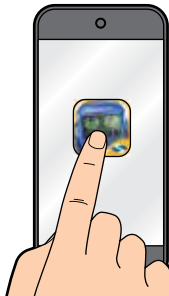

2. Select game on APP.

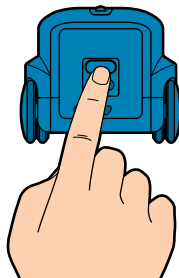

3. Hold button for 2 seconds until you hear a second chime.

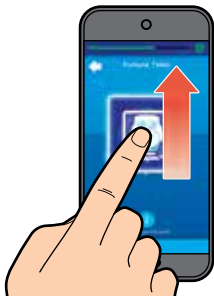

4. Send a game from the app.



More PLAY =
More Games.

explore. play. repeat.

5. To exit APP MODE, wait 45 seconds or push button on back.

game activity mode

SCANNING GAME ACTIVITY CARDS:

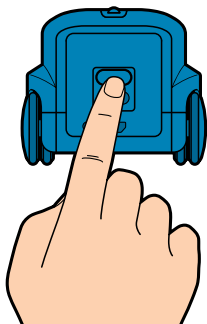

1. Press **BUTTON**.

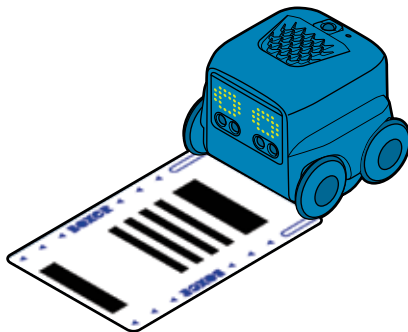

2. Place **BOXER** down on top of **CARD** with front wheels in outline area.

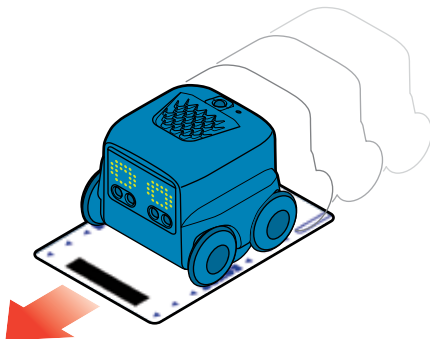

3. **BOXER** will scan **CARD** & launch **GAME**.

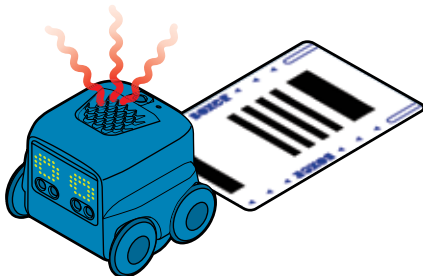

4. **BOXER** will **BEEP** if scan is unsuccessful.

game mode: bot bowling

Use items around your house as pins and send me hurling towards them in a fun game of Bot Bowling. What's 3 strikes in a row? A turkey... gobble gobble (CUPS not included). Press **BUTTON** to exit this Game Activity Mode.

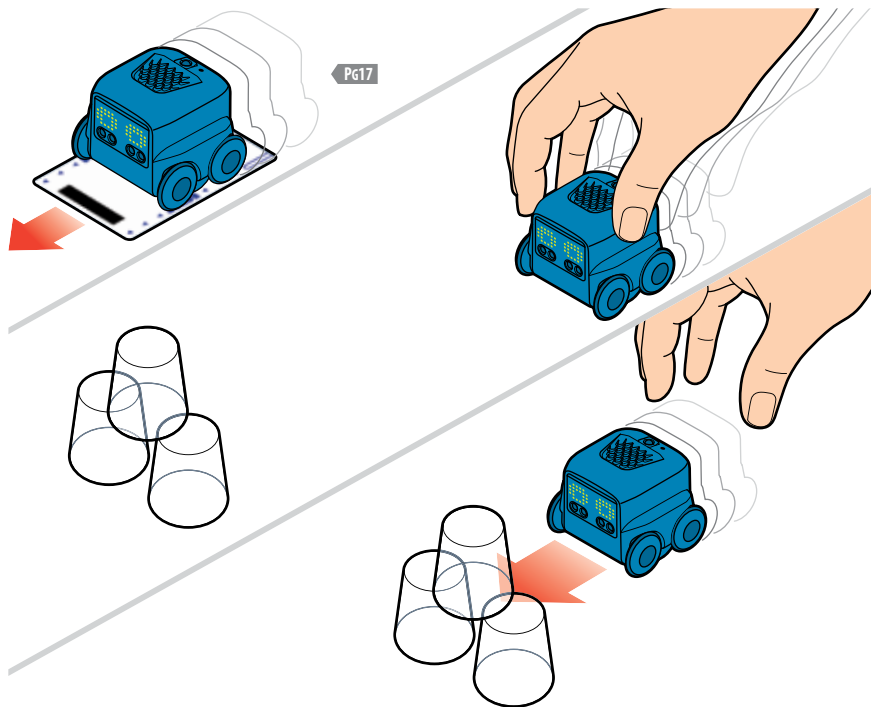

game mode: dj bot

Go DJ, I'm your DJ. Move your fingers in front of my sensors to create awesome beats that I will play back for you and your friends. Press **BUTTON** to exit this Game Activity Mode.

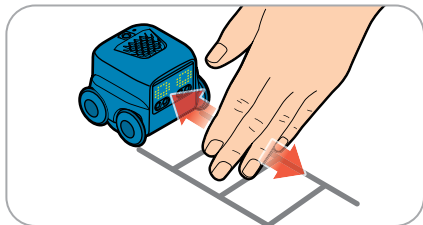
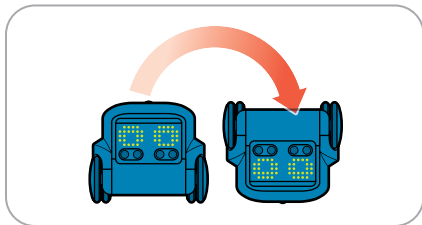
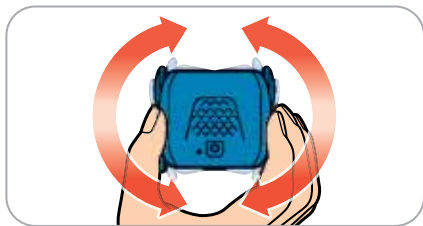
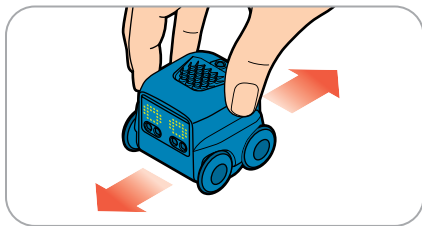
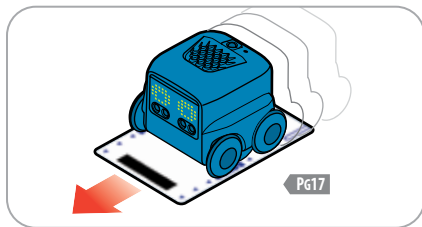

game mode: soccer

Put me in the game, I've got mad skills. When the ball is placed in front of me in Soccer Mode, I will dribble forward and take a shot on goal (Goal posts not included). Press **BUTTON** to exit this Game Activity Mode.

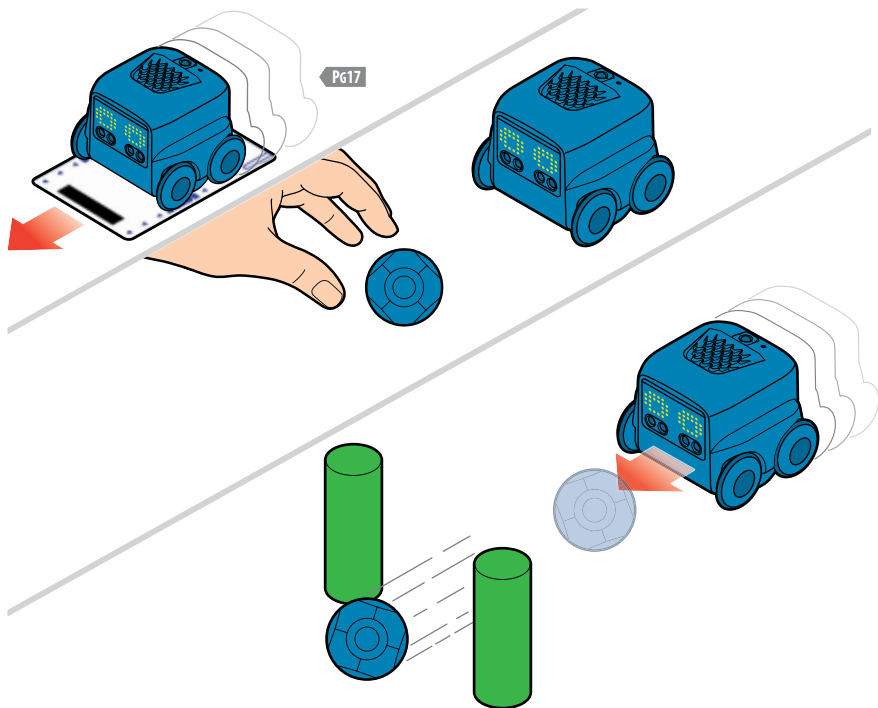

game mode: paddle bot

Grab your friend and bounce me back and forth between your hands.
Press **BT** to exit this Game Activity Mode.

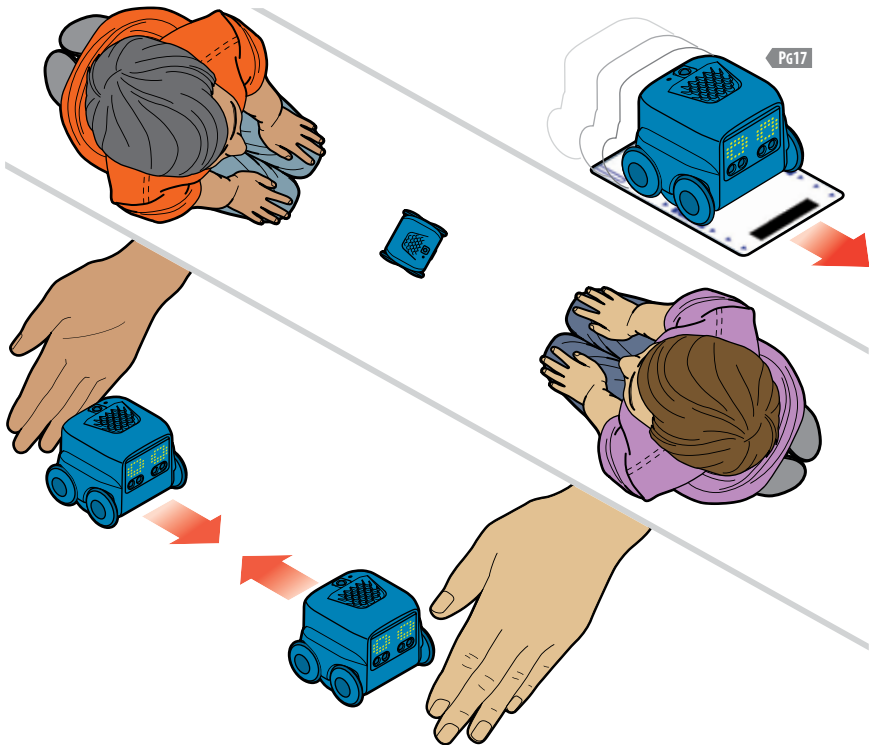

game mode: go kart

Ahhh, the smell of burnt rubber in the morning. Grab the REMOTE CONTROL and get ready to race around the house in Go Kart mode. Use a large sheet of paper and draw a .5" wide line (paper and pen not included) in a continuous loop. Press **BT** to exit this Game Activity Mode.

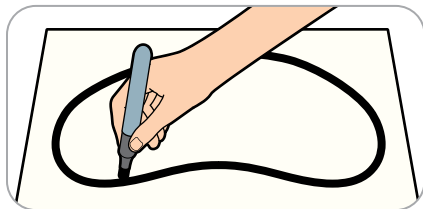

Having trouble drawing your track? Visit www.boxerthebot.com for printouts.

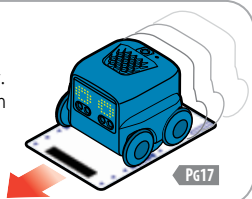

Place Boxer in the center of your paper, off the track, so he can calibrate to follow the line.

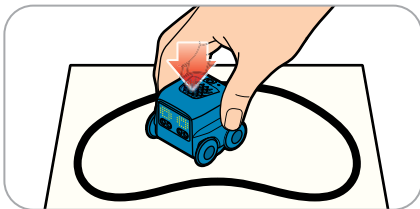
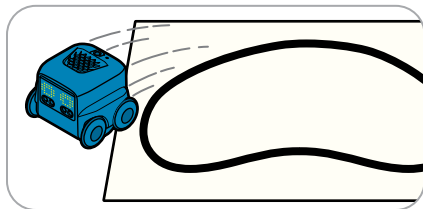
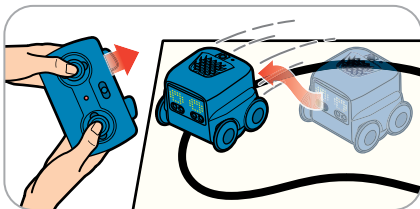
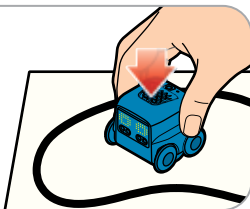

game mode: dance party

Nothing gets my gears moving like my favorite song. Check out my sweet dance moves! Press **BUTTON** to exit this Game Activity Mode.

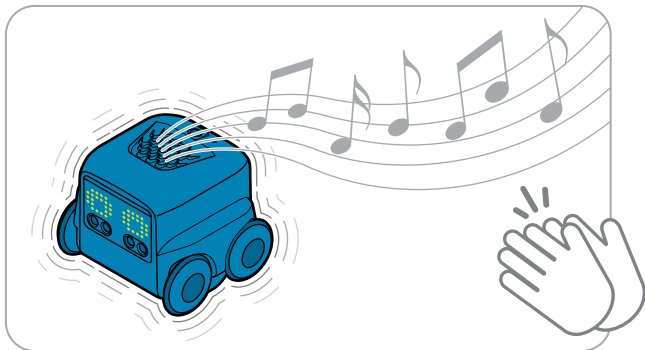
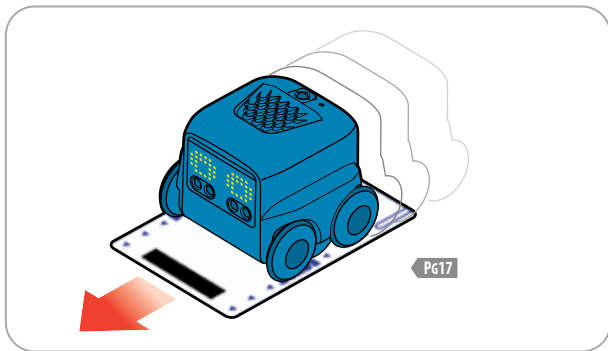

game mode: fortune teller

I've got all the answers. Ask a question, shake me up, and wait for your fortune. Press **BT** to exit this Game Activity Mode.

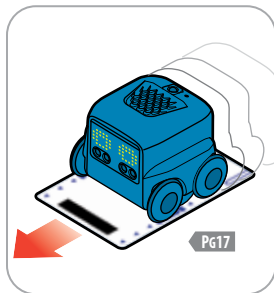

1. Scan **ACTIVITY CARD**.

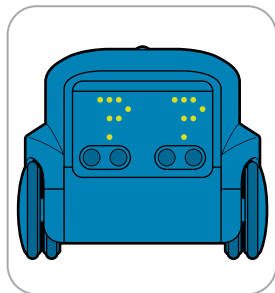

2. Ask **BOXER** a question.

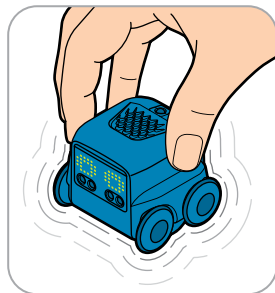

3. Shake **BOXER**.

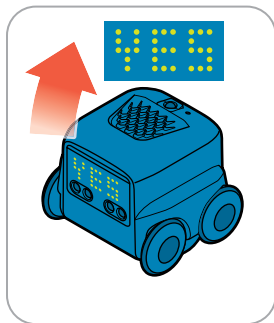

4. **BOXER** will answer your question.

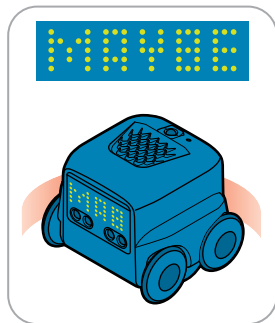
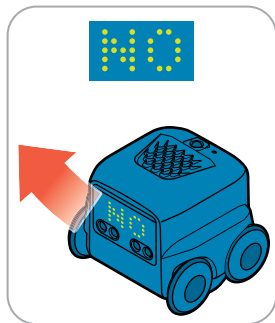

game mode: stunt show

Check it out, I can roll around in wheelies and even do flips!
Stunt Show mode is a total crowd pleaser. Clap & I'll do another stunt.
Press **BUTTON** to exit this Game Activity Mode.

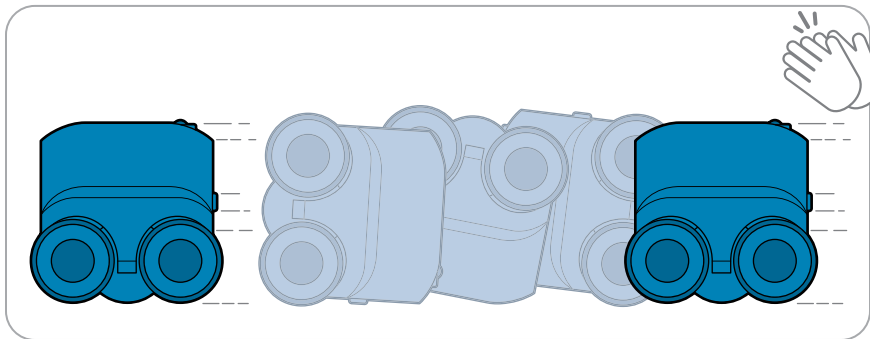
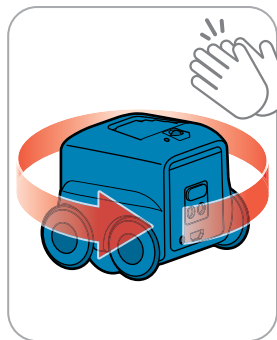
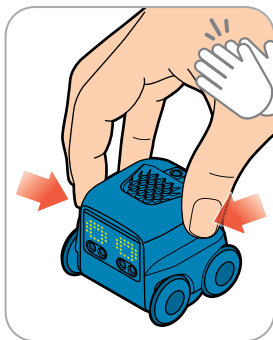
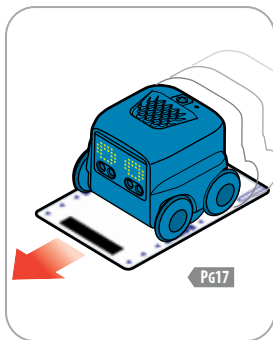

game mode: laser tank

Lasers & Tanks! What could be better? Grab the REMOTE CONTROL and take control of your own Laser Tank. Press **BUTTON** to exit this Game Activity Mode.

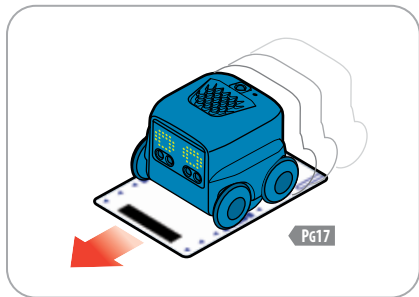

1. Scan **ACTIVITY CARD**.

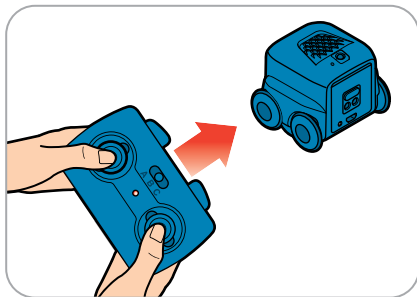

2. Pair **REMOTE CONTROL** to **BOXER**.

- 1.** Mini Blast
- 2.** Mega Blast
- 3.** Ultra Blast
- 4.** Channel Select

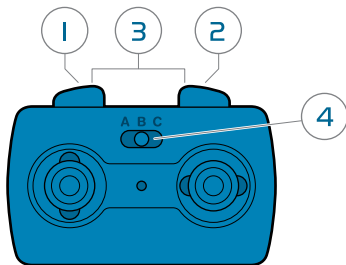

3. **REMOTE CONTROL:** When using multiple boxers, select different channels and pair in isolation. For more instructions go to Boxerthebot.com/help

game mode: sling shot

Steady, Aim, Fire! Pull me back and watch me catapult towards the target
in Slingshot Mode. Weeeeeeeeeeeeeeee!
Press **BUTTON** to exit this Game Activity Mode.

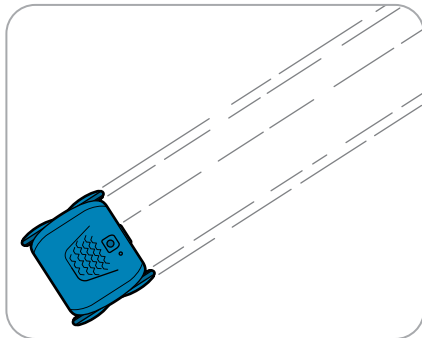
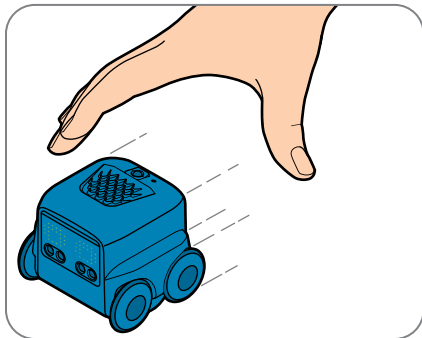
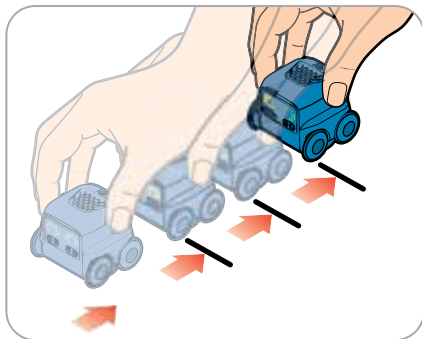
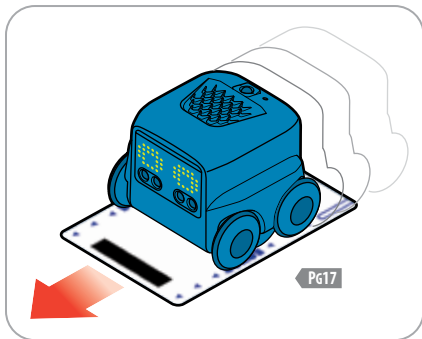

sleep mode

After a few minutes of inactivity, BOXER will go into SLEEP MODE. Press Button on Boxer's back to wake.

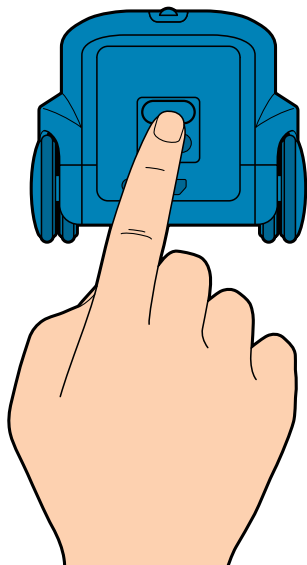

power off

Move the POWER SWITCH to the OFF () position.

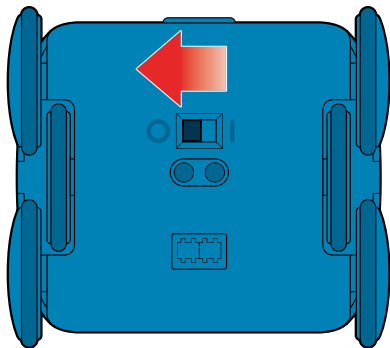

How do I scan a card? Refer to PG.17

Press the button on the back of Boxer and set it down on the card. Be sure the arrows on the card are pointing away from the robot and that the wheels line up on the marked area of the card for optimal reading. Scan on a white surface for best results.

What if I lost my card(s)?

All cards will be available to print at www.boxerthebot.com and available in the Boxer Bot App.

My robot doesn't turn on. Refer to PG.9

The battery is probably not charged. Plug in to the included Micro-USB charging cable.

My robot doesn't charge. Refer to PG.9

Make sure you are using the included micro USB charging cable and that your USB outlet has power. If you have lost the included cable, try using a short Micro-USB cable to charge.

My robot doesn't turn on while it is charging.

For safety reasons, the robot cannot be turned on while it is charging.

My robot doesn't react to my phone.

Refer to PG.16

Make sure your robot is in App mode and that the volume on your phone is turned all the way up so Boxer can hear it. Refer to the section on App mode in the full instruction manual.

NOTE: If normal function of the product is disturbed or interrupted, strong electro-magnetic interference may be causing the issue. To reset product, turn it completely off, then turn it back on. If normal operation does not resume, move the product to another location and try again. To ensure normal performance, change the batteries, as low batteries may not allow full function.

⚠ WARNING: CHOKING HAZARD – small parts and small ball.



REMOVE ALL PACKAGING BEFORE USE. RETAIN THIS INFORMATION, ADDRESSES AND PHONE NUMBERS FOR FUTURE REFERENCE. CONTENT MAY VARY FROM PICTURES.

Spin Master reserves the right to discontinue the website www.boxerthebot.com at any time

SPECIAL NOTE TO ADULTS: REGULARLY EXAMINE FOR DAMAGE TO THE PLUG, ENCLOSURE AND OTHER PARTS. IN THE EVENT OF ANY DAMAGE, THE TOY MUST NOT BE USED WITH THE CHARGER UNTIL THE DAMAGE HAS BEEN REPAIRED. THIS TOY IS NOT INTENDED FOR CHILDREN UNDER 3 YEARS OLD. THIS TOY MUST ONLY BE USED WITH THE RECOMMENDED CONTROLLER.

DOWNLOAD THE FREE BOXER BOT APP



SMART DEVICE NOT REQUIRED. FOR AN ENHANCED EXPERIENCE, PLEASE USE A COMPATIBLE IOS OR ANDROID DEVICE TO PLAY. CHECK COMPATIBILITY AT WWW.BOXERTHEBOT.COM/DEVICES. SPIN MASTER RESERVES THE RIGHT TO WITHDRAW THE APPLICATION AT ANY TIME.



ANDROID, GOOGLE PLAY AND THE GOOGLE PLAY LOGO ARE TRADEMARKS OF GOOGLE INC. APPLE AND THE APPLE LOGO ARE TRADEMARKS OF APPLE INC., REGISTERED IN THE U.S. AND OTHER COUNTRIES. APP STORE IS A SERVICE MARK OF APPLE INC.

FCC STATEMENT: THIS DEVICE COMPLIES WITH PART 15 OF THE FCC RULES. OPERATION IS SUBJECT TO THE FOLLOWING TWO CONDITIONS: (1) THIS DEVICE MAY NOT CAUSE HARMFUL INTERFERENCE, AND (2) THIS DEVICE MUST ACCEPT ANY INTERFERENCE RECEIVED, INCLUDING INTERFERENCE THAT MAY CAUSE UNDESIRED OPERATION.

THIS EQUIPMENT HAS BEEN TESTED AND FOUND TO COMPLY WITH THE LIMITS FOR CLASS B DIGITAL DEVICES PURSUANT TO PART 15 OF THE FCC RULES. THESE LIMITS ARE DESIGNED TO PROVIDE REASONABLE PROTECTION AGAINST HARMFUL INTERFERENCE TO RADIO COMMUNICATIONS. THIS EQUIPMENT GENERATES, USES AND CAN RADIATE RADIO FREQUENCY ENERGY AND, IF NOT INSTALLED AND USED IN ACCORDANCE WITH THE INSTRUCTION, MAY CAUSE HARMFUL INTERFERENCE TO RADIO COMMUNICATION. HOWEVER, THERE IS NO GUARANTEE THAT INTERFERENCE WILL NOT OCCUR IN A PARTICULAR INSTALLATION. IF THIS TOY DOES CAUSE INTERFERENCE TO RADIO OR TELEVISION RECEPTION (YOU CAN CHECK THIS BY TURNING THE TOY OFF AND ON WHILE LISTENING FOR THE INTERFERENCE), ONE OR MORE OF THE FOLLOWING MEASURES MAY BE USEFUL:

- REORIENT OR RELOCATE THE RECEIVING ANTENNA.
- INCREASE THE SEPARATION BETWEEN THE TOY AND THE RADIO OR THE TV.
- CONSULT THE DEALER OR AN EXPERIENCED TV-RADIO TECHNICIAN FOR HELP.

SHIELDED CABLES MUST BE USED WITH THIS UNIT TO ENSURE COMPLIANCE WITH THE CLASS B FCC LIMITS.

NOTE: CHANGES, ADJUSTMENTS OR MODIFICATIONS TO THIS UNIT, INCLUDING BUT NOT LIMITED TO, REPLACEMENT OF ANY TRANSMITTER COMPONENT (CRYSTAL, SEMICONDUCTOR, ETC) COULD RESULT IN A VIOLATION OF FCC RULES UNDER PART 15 AND/OR 95 AND MUST BE EXPRESSLY APPROVED BY SPIN MASTER LTD OR THEY COULD VOID THE USER'S AUTHORITY TO OPERATE THE EQUIPMENT.

An Adult should periodically check this toy to ensure no no damage or hazard exists. If so, remove from use. Children should be supervised during play.



CONTAINS 1 X 3.7V/500 MAH LIPO BATTERY. REQUIRES 3 LR44 BATTERIES (INCLUDED).

BATTERIES OR BATTERY PACKS MUST BE RECYCLED OR DISPOSED OF PROPERLY. WHEN THIS PRODUCT HAS REACHED THE END OF ITS USEFUL LIFE IT SHOULD NOT BE DISPOSED OF WITH OTHER HOUSEHOLD WASTE. THE WASTE ELECTRICAL AND ELECTRONIC EQUIPMENT REGULATIONS REQUIRE IT TO BE SEPARATELY COLLECTED SO THAT IT CAN BE TREATED USING THE BEST AVAILABLE RECOVERY AND RECYCLING TECHNIQUES. THIS WILL MINIMIZE THE IMPACT ON THE ENVIRONMENT AND HUMAN HEALTH FROM SOIL AND WATER CONTAMINATION BY ANY HAZARDOUS SUBSTANCES, DECREASE THE RESOURCES REQUIRED TO MAKE NEW PRODUCTS AND AVOID USING UP LANDFILL SPACE. PLEASE DO YOUR PART BY KEEPING THIS PRODUCT OUT OF THE MUNICIPAL WASTE STREAM! THE "WHEELIE BIN" SYMBOL MEANS THAT IT SHOULD BE COLLECTED AS "WASTE ELECTRICAL AND ELECTRONIC EQUIPMENT". YOU CAN RETURN AN OLD PRODUCT TO YOUR RETAILER WHEN YOU BUY A SIMILAR NEW ONE. FOR OTHER OPTIONS, PLEASE CONTACT YOUR LOCAL COUNCIL.

SPECIAL LIPO BATTERY INSTRUCTIONS:

NEVER CHARGE BATTERY UNATTENDED.

CHARGE BATTERY IN ISOLATED AREA. KEEP AWAY FROM FLAMMABLE MATERIALS.

DO NOT EXPOSE TO DIRECT SUNLIGHT.

THERE IS A RISK OF THE BATTERIES EXPLODING, OVER-HEATING, OR IGNITING. DO NOT DISASSEMBLE, MODIFY HEAT, OR SHORT-CIRCUIT THE BATTERIES. DO NOT PLACE THEM IN FIRES OR LEAVE THEM IN HOT PLACES.

DO NOT DROP OR SUBJECT TO STRONG IMPACTS.

DO NOT ALLOW THE BATTERIES TO GET WET.

ONLY CHARGE THE BATTERIES WITH THE SPECIFIED SPIN MASTER™ BATTERY CHARGER.

ONLY USE THE BATTERIES IN THE DEVICE SPECIFIED BY SPIN MASTER™.

CAREFULLY READ THE INSTRUCTION GUIDE, AND USE THE BATTERIES CORRECTLY.

IN THE UNLIKELY EVENT OF LEAKAGE OR EXPLOSION USE SAND OR A CHEMICAL FIRE EXTINGUISHER FOR THE BATTERY.

BATTERIES MUST BE RECYCLED OR DISPOSED OF PROPERLY.

PRODUCT BATTERY REMOVAL INSTRUCTIONS:

INTERNAL BATTERY IS FACTORY INSTALLED AND NON-REPLACEABLE. PRODUCT DISASSEMBLY AND BATTERY REMOVAL MUST BE PERFORMED BY AN ADULT. DO NOT PUNCTURE, CUT, TEAR, COMPRESS OR DEFORM PRODUCT DURING DISASSEMBLY. ENSURE PRODUCT IS TURNED OFF, THEN USE A SCREW DRIVER TO REMOVE ALL SCREWS. SEPARATE PRODUCT BODY HALVES TO EXPOSE INTERNAL ELECTRONICS. WHEN BATTERY IS VISIBLE IN ITS ENTIRETY USE SCISSORS TO CUT A SINGLE BATTERY WIRE, IMMEDIATELY WRAP THE CUT WIRE END WITH TAPE TO ISOLATE IT, REPEAT UNTIL ALL BATTERY WIRES ARE CUT AND ISOLATED, AND THE BATTERY IS FREE FROM THE REST OF THE PRODUCT. DISPOSE OF BATTERY IN ACCORDANCE WITH YOUR LOCAL BATTERY RECYCLING OR DISPOSAL LAWS. NOTE: OPENING OF PRODUCT AND/OR REMOVAL OF BATTERY WILL RENDER PRODUCT INOPERATIVE AND VOIDS MANUFACTURER WARRANTIES, DISPOSE OF REMAINING PRODUCT COMPONENTS IN ACCORDANCE WITH LOCAL LAWS.



TM & © Spin Master Ltd. All rights reserved. SPIN MASTER LTD., 225 King Street West, Toronto, ON M5V 3M2 Canada.
Imported into EU by Spin Master International B.V., Kingsfordweg 151, 1043 GR Amsterdam, The Netherlands.

www.spinmaster.com

Made in China

T75100_0001_20101459_GEN_IS_R4