













17

-  x 2
-  x 1
-  x 3
-  x 1
-  x 1
-  x 1
-  x 1
-  x 1

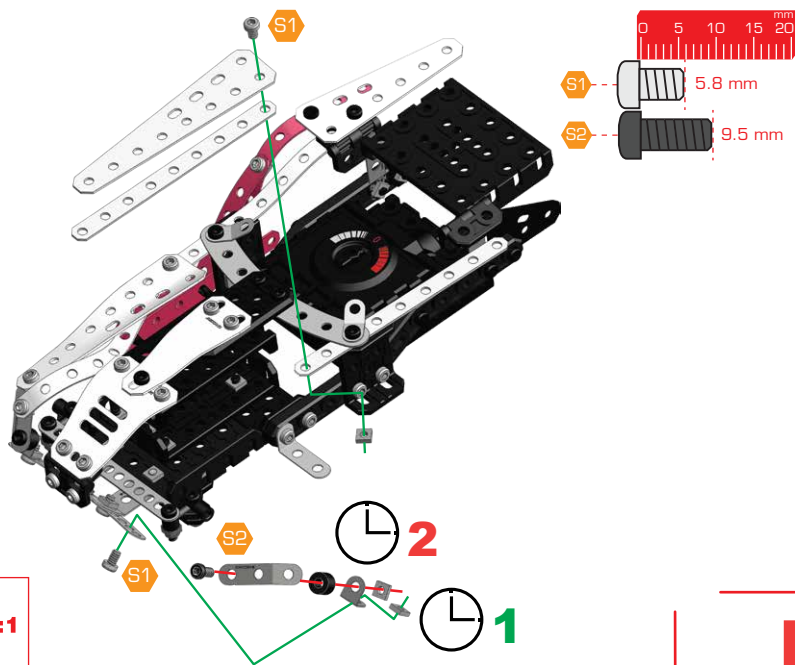



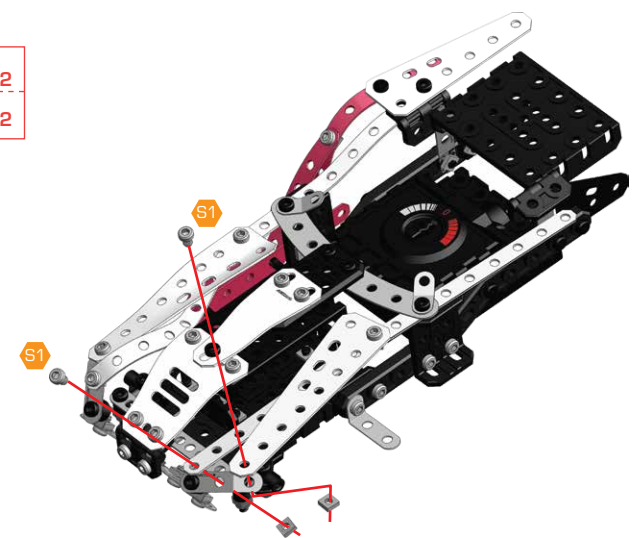

18

-  x 2
-  x 2
-  x 2







19

-  x 1
-  x 1
-  x 3
-  x 1
-  x 1



20

-  x 3
-  x 3
-  x 1
-  x 1
-  x 2

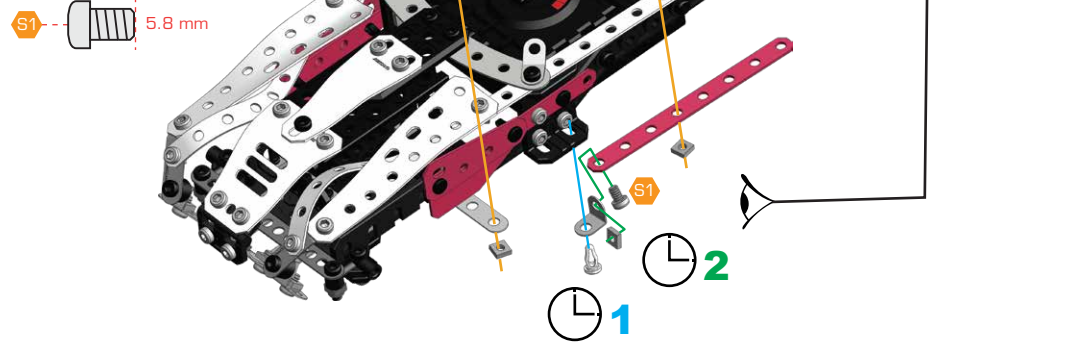

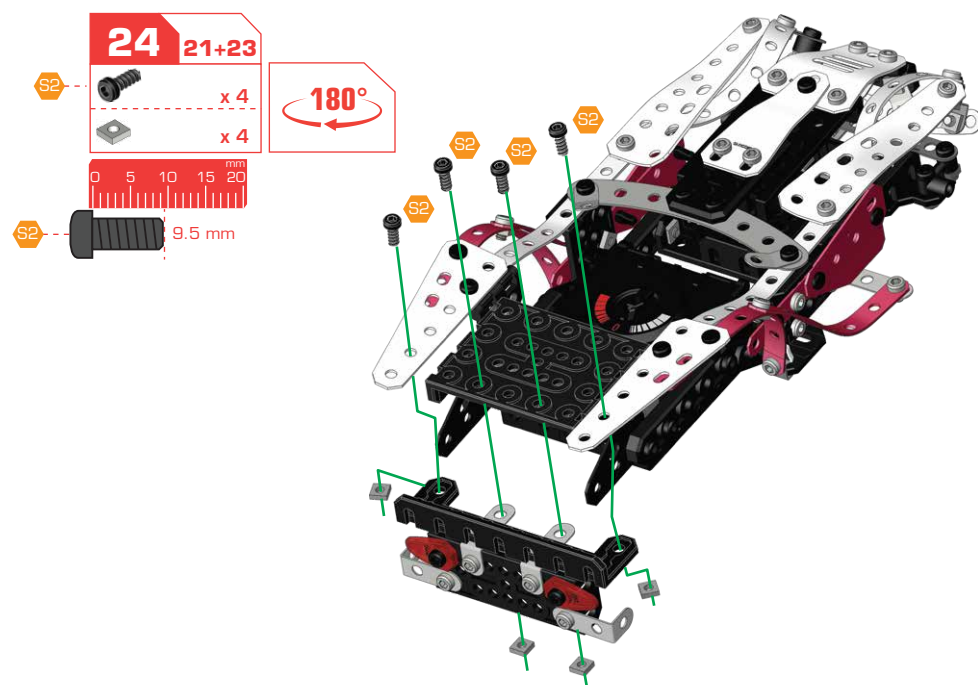
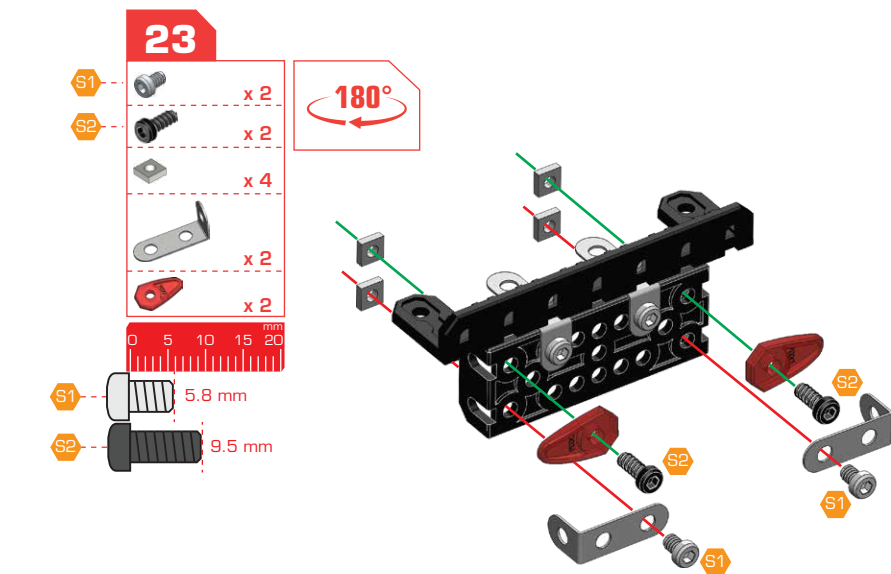
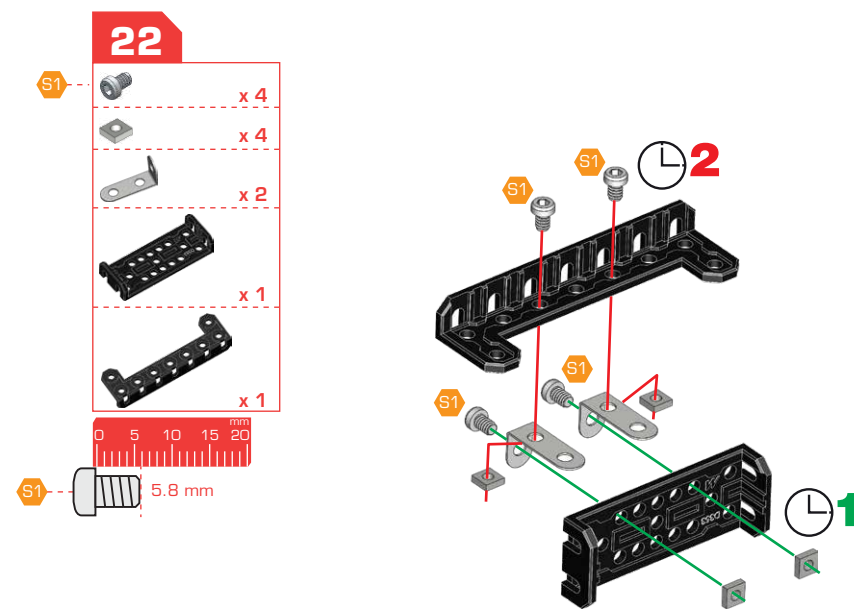
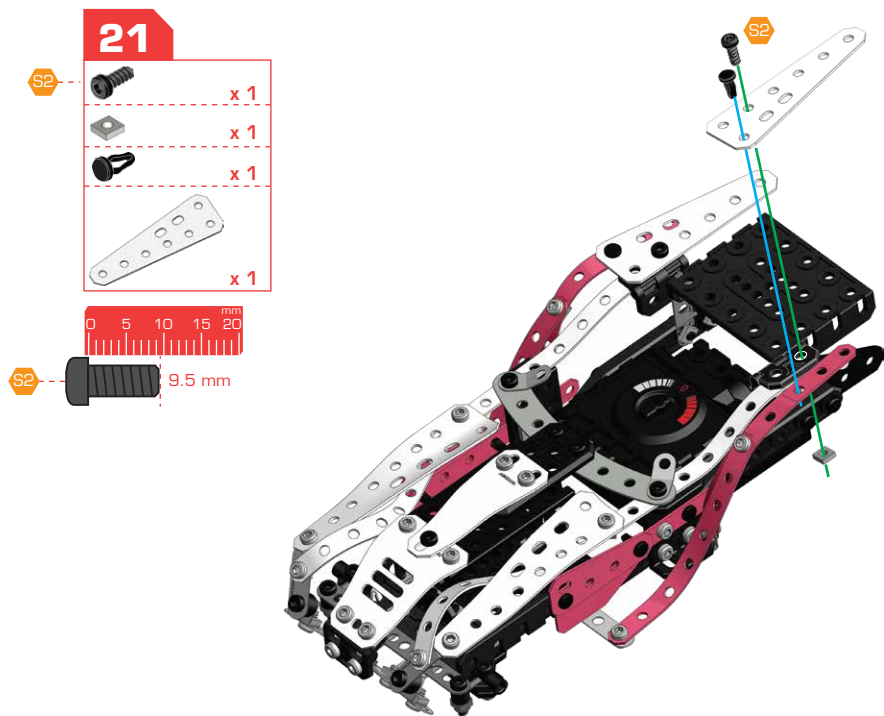

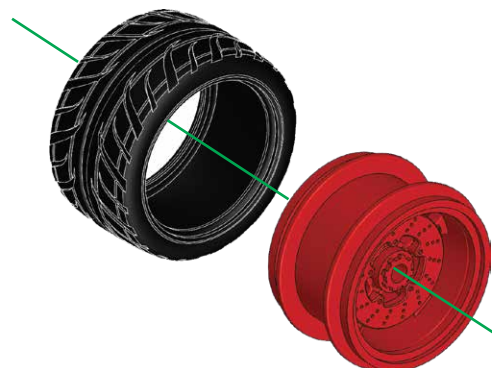
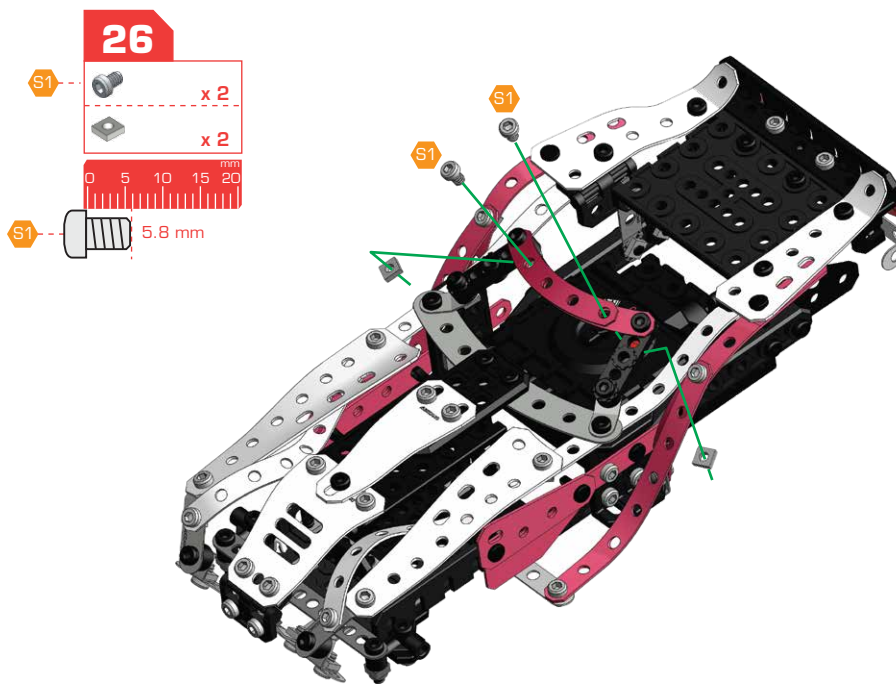
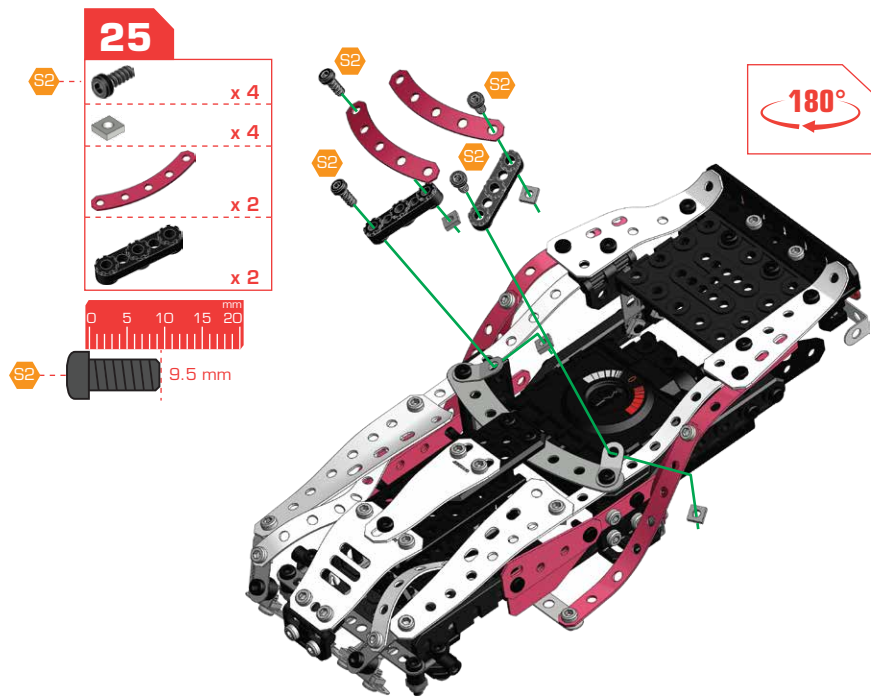

28 26+27

- x 2
- x 2

0 5 10 15 20 25 30 mm

23 mm

A238 1:1

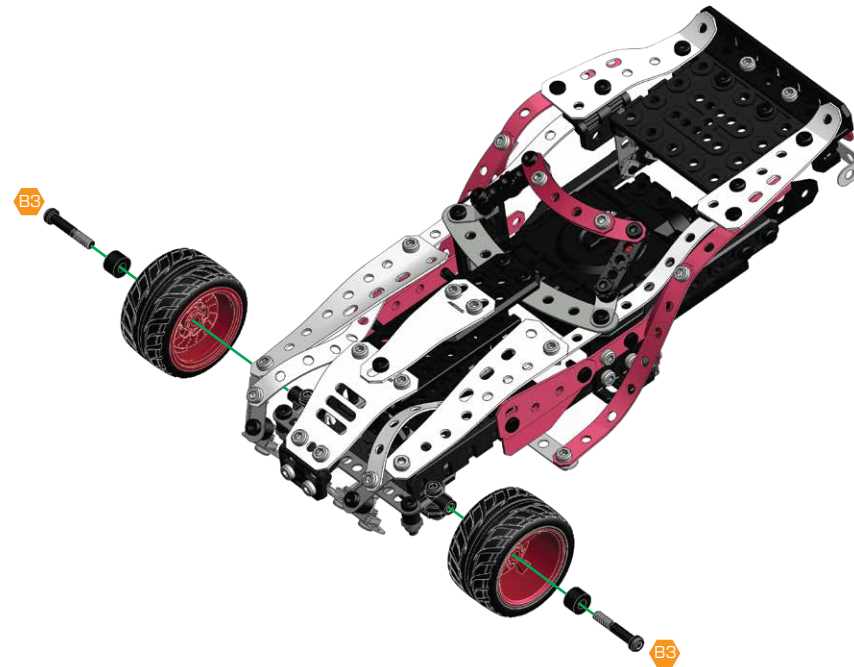

29 27+28

- x 2
- x 2
- x 2
- x 1

